

DER GASSER

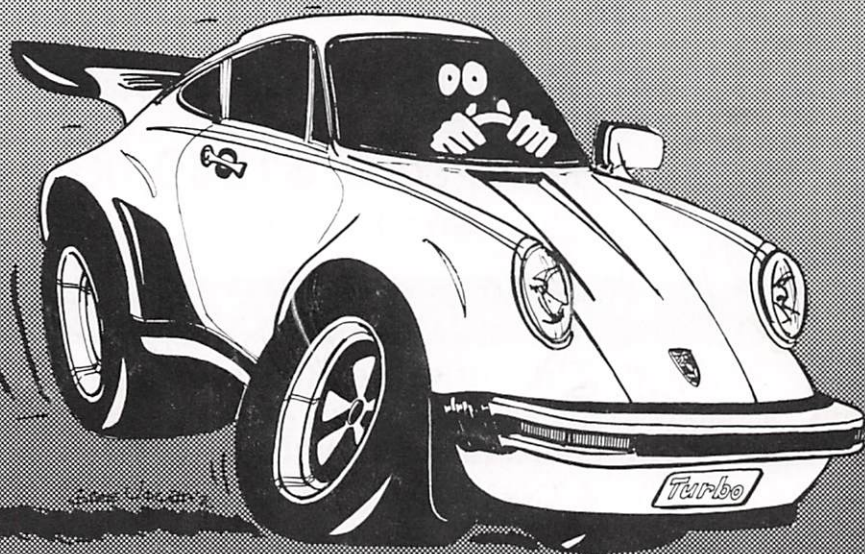

September 1987

30th YEAR



RIESENTÖTER REGION

PORSCHE CLUB OF AMERICA

IF YOU PARTICIPATE IN
Time Trials· Drivers' Schools

Holbert Racing has your Safety Equipment!



HELMETS

1985 Snell approved

DRIVING SUITS

Maximum protection
with guaranteed fit.



Forged hardware.
custom-fitted.

AEROQUIP

PLUMBING

Professional use for
the street or track.

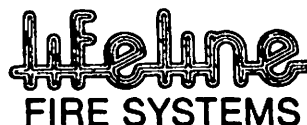

Have we got some DEALS for you!

AUTOCROSS / TIME TRIAL SPECIAL

Buy **FOUR BBS 1-Piece Black Center Wheels**
(Either four 15x7 or two 15x7 and two 15x8)

PLUS...4 SHAVED BFGoodrich COMP T/A TIRES!

(Choose either 225/50x15 or 245/50x15)

Regular Retail for This Package: \$1696.00

**HOLBERT'S
PKG. SPECIAL: \$1060.00**

Save Over \$600.00!

TOURING SPECIAL

The Ultimate Road Wheel!

When you buy **FOUR BBS RS (Modular Sport) WHEELS**
at regular price **WE WILL GIVE YOU . . .**

4 COMP T/A TIRES FREE!!

Example . . .

Two 7 x 16 RS 012 w/205/55x16 Comp T/As

Two 8 x 16 RS 013 w/225/50x16 Comp T/As

TOTAL PKG. ONLY: \$2438.00

Call for other packages! **HOLBERT RACING** also features:

BBS racing modular wheels for street • Special finishes & custom painting for BBS Wheels!



HOLBERT RACING INC.

To Make An Intelligent Purchase
Buy From A Knowledgeable Source

1425 Easton Road, Warrington, PA 18976
215-343-3131 within PA. TOLL FREE 800-835-5102

DER GASSER

EXECUTIVE COMMITTEE

PRESIDENT

Al Anderson
1015 Thomas Road
Norristown, PA 19401
275-8605 (H)

VICE PRESIDENT

Bill O'Connell
2801 Stoneham Drive
West Chester, PA 19380
640-1675 (H)

SECRETARY

Tony Bonanni
303 Powder Horn Road
Fort Washington, PA 19034
828-9469 (H)
834-1509 (W)

COMPETITION

Robert Lamb
328 Valley Forge Road
Devon, PA 19333
687-4828 (H)
666-9200 (W)

CHIEF INSTRUCTOR

Don Galbraith
201 E. King Street
Malvern, PA 19355
644-4911

EDITOR

Paul Johnston
325 Westtown Road
West Chester, PA 19382

PAST PRESIDENT

Richard van Zijl
Box 1314
Malvern, PA 19355
296-8862 (H)
854-6483 (W)

TREASURER

Vicki O'Connell
2801 Stoneham Drive
West Chester, PA 19380
640-1675 (H)

MEMBERSHIP

Neil Fine
1448 Ford Road
Bensalem, PA 19020
628-8081 (H)
639-92920 (W)

AUTOCROSS

Jim Confer
166 Pugh Road
Wayne, PA 19087
687-1339 (H)
354-5914 (W)

SOCIAL

Larry and Cheryl Herman
8108 Hull Drive
Philadelphia, PA 19118
233-5845 (H)

GOODY STORE

Lisa Confer
Bill O'Connell

CONTENTS

September Meeting	4
President's Message	4
Photos Wanted	4
October Meeting	5
1988 Executive Committee Nominations	5
The 30th	6
Extra October Event	6
The Goody Store	7
Autocross #3	8
Track Events	10
Autocross	11
Solo I	11
The Stumble Start	12

Meetings For 1987 by Bill O'Connell

The 1987 meeting schedule is listed below. Meetings are normally held on the LAST Wednesday of each month, the exception being special events. The regular meetings start at 8:00 with the business segment, followed by the guest or event. Due to our speakers volatile schedules, PLEASE do both of us a favor and check this for changes each month.

DATE	LOCATION	SUBJECT
09/30	VF Sheraton	Bob Akin
10/18	Arthur's	Extra meeting
/27	Rheinland Inn	Octoberfest
12/19	Curtis Hall	Christmas Dinner

NOTE: the change in September's meeting place. The Valley Forge Sheraton is located on Rt. 363. From the PA Turnpike, exit at Valley Forge and take the FIRST exit after paying the toll. Follow 363 toward Valley Forge Park and the hotel is on the right at the second traffic light.

ADDRESS CHANGES Should be sent to the MEMBERSHIP Chairman at least one month prior to your move.

CLASSIFIED and ARTICLES. Ads are FREE to members, \$10 per issue to others. They are NOT automatically reprinted. Articles and/or pictures dealing with RTR events, Porsches, or topics of general interest are welcome. Those with letter quality (not dot matrix) printers or typewriters can submit them in columns of 3 1/4 X 10 otherwise, they should be typewritten between 200 and 800 words in length. Pictures should have good contrast and be 3 1/2 X 5, color or black and white. The deadline is the 1st of each month and can be given to the editors at the meeting or mailed to the address listed in the EXECUTIVE COMMITTEE.

DER GASSER is the official publication of the RIESENTOTER region of the Porsche Club of America. Unless otherwise stated, comments and/or articles are those of the author and not necessarily those of PCA or Riesentoter.

SEPT MEETING, etc.
WED, SEPT 30th SHERATON, Valley Forge
by Bill O'Connell

The September meeting is at the Sheraton in Valley Forge featuring Bob akin. For those new members, Bob races a 962 painted like a coke can and is an excellent speaker. He lives in New York and honors us once each year. His meeting is very well attended so get there early for a good seat. He is always loaded with humorous little tidbits about the season.

This is also the meeting to nominate anyone that wants to run for a position on the Executive committee. The nominations close at the end of business at this meeting.

DIRECTIONS: From the PA Turnpike, take the KING OF PRUSSIA/VALLEY FORGE exit. After paying the toll, take the FIRST exit which is Rt 363. Follow 363 toward Valley Forge Park and the hotel will be on your right.

PRESIDENT'S MESSAGE

By Al Anderson

The 30th Anniversary celebration is here and gone, but what a great weekend it was! I hope all of you enjoyed yourself as much as I did, and I thank you for your help and participation. But let's not think the rest of the year is anti-climatic. We are returning to the Rheinland Inn for our Octoberfest and elections, the Inn will have something special this year, see Bill's article for details and date. You wouldn't want to miss the atmosphere of this old German Inn...watch for the upcoming 30th Anniversary Special Issue of Der Gasser, it's worth saving!

Al Anderson

Al Anderson
INCORPORATED

HAND PAINTED CENTER CAPS
STRIPING AND MONOGRAMS

275-8605



PHOTOS WANTED

Next month's issue of Der Gasser will feature articles and pictures about the 30th Anniversary Weekend. If any of you photo journalists in attendance have any interesting or at least clear pictures of the weekend, please send them to the editor. All pictures can be returned whether we use them or not. Lets make this the best issue yet.

BRIDGESTONE

Leitzinger Motorsports

P.O. Box 47
2401 Commercial Blvd.
State College, PA 16801

1-814-234-5666
1-800-344-3933 Toll Free
1-800-457-8181 (In PA)

JOHN BAKER

Mobil  Formula 15W-50,
developed for today's motorists
who drive cars with high
performance, high tech engines.

Mobil 1 Formula 15W-50 is ideal for those motorists who prefer or require a higher viscosity, superior motor oil. Formula 15W-50 exceeds car manufacturers' recommended requirements for high tech engines of the latest imports.

Mobil



- Outperforms all conventional Premium 20W-50 motor oils
- Superior high-temperature protection for high performance cars
- Optimum turbocharged engine protection
- Flows at -55 F and pumps to critical parts at -35 F
- Helps higher revving engines last longer under high acceleration and provides outstanding cleanliness and wear protection in hot running engines

\$35.00 per 12 quart case + shipping

Call (215) 644-4000 Mauger-Simpson Mobil Dist.

**OCTOBER MEETING
OCTOBER FEST, Tuesday, October 27th
ELECTIONS, DINNER, AND --- THE AUCTION!!!!**

The October meeting is returning to the Rheinland Inn and will be on a week night. This allows us to have a good meal at a reasonable price and gives you a breather between the 30th and Christmas. The inn is normally closed on Tuesdays, so we have it all to ourselves, which means we get restaurant quality food and the ability to pack in 120 people with no disruptions. For those who have never seen a Bob Russo auction, you're in for a treat. He is sure to send you home with something you can't live without. This meeting is also the election, another good reason to attend! And in my never ending attempt to please as many as possible, those that wish to attend the auction and vote but not eat are more than welcome. There is plenty of space at the bar and additional seating. You do NOT have to attend dinner to attend the meeting and vote. The directions and a sign up form are in this issue. PLEASE, PLEASE, sign up in advance. Watch next month for more info on this exciting meeting.

**1988 EXECUTIVE COMMITTEE
NOMINATIONS**

The official slate for next years Executive Committee is as follows:

President	Bill O'Connell
Vice President	Debbie R. Cooper
Treasurer	Vicki O'Connell
Secretary	Tony Bonanni
Membership	Skip Corey
Competition	Jim Confer
Autocross Chairman	Betsi Marsh-Leidy
Social	Mindy Benn
Editor	Paul Johnston

Anyone interested in running for any of the above positions can make their intentions officially known at September's meeting. The elections will be held at the Octoberfest.



CHASE & HECKMAN is able to insure your Porsche, regular autos and home by special arrangements with a major U.S. Insurance Company, at competitive prices, without using the Assigned Risk or substandard markets. Please call John Heckman for details, or see him at the next club function.

CHASE & HECKMAN

I N S U R A N C E

709 BETHLEHEM PIKE/PHILADELPHIA, PA 19118
City 248-4445/Suburbs 836-1274/Home 836-9168

PERFORMANCE FROM EXPERIENCE



Experience takes time. Everyday for thirty years the Holbert Family has been selling, servicing and winning races with Porsche, Audi and Volkswagen cars. Performance from that experience shows on and off the race track. Holbert's service has been named the Grand Award winner of the nationwide "We Care" Porsche Audi Service Excellence Program for the past four years. Winning experiences and dedication develop the performance people look for when buying and owning a luxury or economy car. Come to Holbert's for your Porsche, Audi or Volkswagen.

HOLBERTS
Performance from Experience





1000 Washington Ave. (6 miles North of Willow Grove)
Philly 269-9900 - 978-243-1600 Leasing and Body Repair

THE 30TH by Bill O'Connell

Just a short blurb on The 30th weekend, it was a blast. On Friday, I was running around getting beer and ice, fielding phone calls from last minute entries ("Can I still come?" "What if it rains tonight?"), and wondering if it was really going to all come together when out of the blue comes a phone call from Steve's Detailing - they wanted to do something nice for everyone and wondered if a FREE hand wash for everyone would be ok! OK? A free hand wash 'till the end of September. It seems my worries were in vain. 170 people ate dinner Saturday night! Over 50 cars were displayed on the beautiful lawn at Radnor Hunt! Over 60 people braved the rain and came to Betsi and Doug's Friday night! Freda Meats supplied hundreds of hot dogs and hamburgers which went away and were washed down by 5 kegs of Strohs, 1 keg of birch beer, and 10 cases of soda on Sunday! What a great turnout. I want to thank everyone that assisted and those that attended the various events over the weekend. The October issue will have all the pictures and articles about it. Thanks again.

EXTRA OCTOBER EVENT **SUN, OCT 18th ARTHUR'S** by Bill O'Connell

Arthur's Professional Automobile Care, Inc., 117 N 23rd Street will be hosting a special event on October 18th from noon to 4. They will be covering their method of detailing and how to prep your car for the impending snow, salt, and drudge of winter. There will be other vendors there, such as All That Jazz, displaying their wares and answering your questions. These gatherings have been very popular with other clubs and should prove valuable to you. If you have any questions, give me a call or contact Arthur's at 557-9525.

CELLULAR
COMMUNICATIONS
EXPERTS!



**EASTERN CELLULAR
MOBILE SYSTEMS, INC.**

CUSTOM
INSTALLATIONS
Immediate installation at
Your Location or Our Shop
Service Plans to Meet Your
Individual Needs
Portable Briefcase Telephones
Call for Free Demonstration &
Consultation at Your Location

**373-1400
327-8003**



Authorized Agent for
Bell Atlantic Mobile Systems

GRAPHICS CREATIONS

LOGOS
ADVERTISEMENTS
PAGE LAYOUTS
NEWSLETTERS
REPORTS
PROPOSALS

Your ideas can be transformed into high quality photo-ready copy
quickly and at a reasonable cost.

You don't have to send out flyers and ads done on your typewriter
or dot matrix printer anymore.

Mark Wexler

(215) 524-9527
(Evenings)

THE GOODY STORE

LISA CONFER, Prop.

The goody store is back and running. We have some great goodies for you and your favorite car. If there is something you want let us know. If the demand is high enough we will start stocking it. We also can order many things and will soon be selling some of the products at our advertisers' stores. Once the program is in place, you will be able to buy the stuff from them instead of waiting for the meeting. Watch for more information.

Currently we have some good buys on a few items that would make any Porsche owner happy:

-Saratoga tops are still available in two ways: 1) 944/924 power roofs at a 25% discount, and 2) a \$50 discount on any other top. You can use your Visa/Master Card for these items.

-We also have a special on AUTOBROIDERY shirts. These are 100% cotton interlock with ribbed collar and sleeves and are currently advertised in Pano. The member price is \$25.00, a \$10.00 savings! They come in red, white, navy and silver with a 911, or a 356 embroidered on them. We will have a sample of the 911 and 944 shirt at the meetings and events, so get your orders in early to avoid the Christmas rush.

-We are clearing out the wax, polish, wheel cleaner department. Everything is discounted so stock up now.



Mastco

**EXPERIENCED COMPUTER
CONSULTANTS**

Micros through Mainframes

*No technical talk, just plain ENGLISH you can
understand*

Services -

- Custom design and programming
- Review/evaluation of existing computer packages for your specific business
- Guidance in choosing the PROPER computer equipment
- Local area networking
- Training

DISCOUNTS TO PCA MEMBERS

*Call William O'Connell or David Wargo
(215) 640-1585*



MEDIA STATION AUTOMOTIVE, INC.

640 S. RIDLEY CREEK RD.

565-5535

**Quality Import Service
BMW, Volvo, Porsche and Mercedes
Specialists**

— Featuring —

**HUNTER Computerized
4 Wheel Alignment**

Emission Inspection

State Inspection

Valet Service Available



**AUTOMOTIVE
SERVICE
ASSOCIATION
MEMBER**

AUTOCROSS #3 - THEY FOUND THE COURSE !

By Jim Confer

Forty-two drivers braved the beautiful weather to test their skills on the Sheraton's lot on Sunday, August 9. From an administrative standpoint, I didn't encounter a single difficulty (OK, maybe one, but I won't discuss that). I arrived early to find an empty lot - ZERO parked cars. Except for that one paperwork problem that I'm not going to mention, everything went very smoothly.

The SCCA autocrossers in the club arrived from Allentown just in time to take all the F.T.D. trophies. Vern Lyle took the overall F.T.D. with a 48.955. Mark Schnoerr went home with F.T.D. Stock by clocking a 49.910. Melody Lyle rounded out the group taking F.T.D. Ladies with a 51.806.

A-Stock went to another SCCA competitor, Ron Lego, with a 52.231. Dave Donohue and Bill Miller battled it out for second and third, respectively, while Bill Cooper took fourth. Languishing back in fifth was yours truly grumbling something about poorly adjusted swaybars, wrong tire pressures, no time to walk the course... (I'm still trying to think up a good one). Don Cox turned some impressive times but never quite managed to find the complete course.

Mike Weaver won B-Stock with a 53.185 while Rex Carle edged out Art Rothe for second place.

The C-Stock class is starting to get the hang of this with the first run being the only one prone to off course excursions. Mike Broennle took top honors with a 56.320. Jeff Bok beat Gerry Weger for second while our lone 928 driver, Skip Chalfont, came home in fourth.

Of course, Mark Schnoerr won D-Stock again. Nick Plenzick slipped by John Crowley by less than 0.02 seconds to take second place (which is a victory in this class). Larry Lewis took home his first hardware by placing fourth.

Betsi Leidy (another SCCAer) won Ladies Six Cylinder over Debbie Cooper. Without the penalty, Debbie's last run was only 0.004 seconds behind Betsi. Janet Weger won the Ladies Four Cylinder class.

Four Cylinder Modified went to Rich Benn in a good battle with Dick Sweigart. Dick has been helping at all the autocrosses even though his car was under repair earlier in the season.

Vern Lyle beat out Bob Russo in the Modified Six Cylinder class. Bob, who upheld Reisentoter's honor by driving very well in last year's Portland Parade, tried everything - rain race tires, swaybar adjustment, dry race tires, and stalling for the last run - but fell just a little short. Blame it on poor course design; maybe that's why I had all those problems. Who designed that course anyway?

The Porsche-Corvette Challenge is a definite maybe for October or November. I'm working on a site and a date. Details will be provided if and when they materialize.

- windshield repair •
- vinyl repair • leather repair •

CALISMA

Michael R. Murphy

4975 West Chester Pike, Box 132
Edgemont, PA 19028

(215) 696-1114
(215) 353-5070

**Gary
maucher
CUSTOM UPHOLSTERY**
360 S. Lincoln Ave
Newtown, PA 18940
ANTIQUE, EXOTIC, MARINE
860-0910

AUTOCROSS EVENT #3

AUGUST 9, 1987

<u>A-STOCK</u>	RUN 1	RUN 2	RUN 3	RUN 4	
Ron Lego	53.468	57.955	53.164	52.231	T
Dave Donohue	54.733	54.167	54.547	53.155	T
Bill Miller	O/C	55.952	54.311	53.344	T
Bill Cooper	O/C	55.242	53.992	O/C	T
Jim Confer	1:00.162(2)	58.024(1)	55.355	54.353	T
Joe Fabiani	56.431	59.847(2)	56.776(1)	54.483	
Paul Richardson	O/C	58.779	58.009	55.118	
Don Cox	O/C	O/C	O/C	O/C	
John Rosenblum	O/C	O/C (hired a professional driver)			

<u>B-STOCK</u>					
Mike Weaver	54.617	55.131	53.185	O/C	T
Rex Carle	O/C	56.223	O/C	55.055	T
Art Rothe	55.159	55.939	O/C	55.529	T
John Harkins	1:00.059	O/C	56.465	55.330	
Tom Sclafani	O/C	59.121	58.686	58.937	

<u>C-STOCK</u>					
Mike Broennl	1:01.396(1)	58.370	56.320	56.429	T
Jeff Brok	1:00.539	O/C	58.491	57.413	T
Gerry Weger	O/C	59.525	1:00.650	57.993	T
Skip Chalfont	O/C	58.279	O/C	1:00.446(2)	T
Mike Murphy	O/C	59.325	59.535	58.407	
Adam Varrenti, Jr.	O/C	1:01.016	1:02.919	59.087	
Jim Donaghy	O/C	O/C	1:01.144	1:00.394	
Fred Raach	1:10.966	1:03.969	1:03.211	1:03.667	

<u>D-STOCK</u>					
Mark Schnoerr	52.766(1)	52.610(1)	49.910	50.281	T
Nick Plenzick	1:00.908	59.699(1)	59.107	58.154	T
John Crowley	1:05.951	59.092	59.233	58.173	T
Larry Lewis	1:06.140	1:03.569	59.950	O/C	T
Dion Ranio	O/C	1:03:355	1:00.608	1:00.826	
Fred Matolice	1:04.333	O/C	1:05.710(2)	O/C	

<u>LADIES SIX CYLINDER</u>					
Betsi Leidy	58.038	57.953	1:01.963(2)	56.657	T
Debbie Cooper	1:01.552	1:00.087	58.920	58.661(1)/T	
Sybil Margaritis	1:16.731	O/C	1:07.112	1:05.464	

<u>LADIES FOUR CYLINDER</u>					
Janet Weger	1:09.317	1:03.914	1:01.552	O/C	T
Suzanne Bauerle	O/C	1:06.655	O/C	1:04.612	
Melissa Pienzick	O/C	1:22.486	1:07.473	O/C	

<u>LADIES MODIFIED</u>					
Melody Lyle	O/C	54.433	O/C	51.806	T

<u>FOUR CYLINDER MODIFIED</u>					
Rich Benn	57.140	55.938	53.755(1)	55.239	T
Dick Sweigart	57.737	57.307	57.775	55.782	T

<u>SIX CYLINDER MODIFIED</u>					
Vern Lyle	49.598	49.926	49.219	48.955	T
Bob Russo	O/C	51.831	53.101(1)	52.611	T
Paul Margaritis	1:00.235	53.792	55.791	58.789	
John Williamson	O/C	57.554	56.365	1:01.130(2)	

FASTEST TIME OF DAY - VERN LYLE	48.955
F.T.D. STOCK	MARK SCHNOERR 49.910
F.T.D. LADIES	MELODY LYLE 51.806

D·E·T·A·I·L·I·N·G



At CALIFORNIA AUTO DETAILING, skilled craftsmen meticulously clean and condition your automobile inside and out. Finishing touches require tools like Q-tips®, cotton diapers and feather-soft makeup brushes to ensure that every nook and cranny of your car's finish sparkles with pristine brilliance. Call "Philadelphia's Finest" today for your appointment or stop in for a free consultation and estimate.

(215) 487-0780

"California Auto Detailing"
Meticulous Hand-Cleaning of Fine Automobiles

Where the Belmont Avenue Bridge Meets Manayunk Corporate Accounts Welcome

You and your Porsche deserve the best ...

CAR FARE Ltd.



7946 Germantown Avenue
Chestnut Hill, Pa. 19118
215-247-6340

Rag'in Piano Boogie

FESTIVALS
PICNICS
BLOCK PARTIES
PROMOTIONS
Any OUTDOOR OCCASION

P.O. Box 1481
Philadelphia, PA 19105
(215) 923-3644

Played @ 30th Weekend

Tentative 1987 Track Events

These events are subject to change and more may be added. For more information on an event, contact the chairperson of the proper committee. For events not sponsored by RTR, contact the club holding the event. **IT IS IMPORTANT** that you respond early for all events, as many fill on the first day of registration.

Events at Watkins Glen, Summit Point, Lime Rock, etc. are all High Speed, and when sponsored by a PCA region, are classified as a High Speed Driving School.

All events are run by PCA regions unless marked with an "*".

Prior to RTR driving events, we will hold a tech session to check out your car. Watch for the time and place.

<u>Date</u>	<u>Sponsor</u>	<u>Place</u>
SEP 14 & 15	Tracktime	Watkins Glen
18, 19 & 20	Ron Fox	Bridgehampton
OCT 3 & 4	NNJR Open	Pocono
" (CANCELLED)	RTR	Watkins Glen
4	POT	Summit Point
24 & 25	NNJR Open	Summit Point
24 & 25	Tracktime	Charlotte Motor
29	CVR	Lime Rock
30	H-C	Lime Rock
31	SHATT	Lime Rock
NOV 5, 6 & 7	CVR	Lime Rock
14 & 15	POT	Summit Point



PCA CLUB CONTACTS

CVR - Connecticut Valley
 Russ Pratt
 Pratt General Contractors
 Route 6
 Columbia, CT 06052
 203-223-3373

H-C - Hudson-Champlain
 Tommy Thompson
 19 Lynn Drive
 Albany, NY 12206
 518-869-5992

NNJR - Northern New Jersey
 Richard Schmidt
 29 Fair View Avenue
 Hartland, NJ 07506
 201-423-1770

POT - Potomac
 Dan McChesney
 10407 Mountain Quail Road
 Silver Spring, MD 20901
 301-681-3712

SHATT - Schattembaum
 Peter Tremper
 450 Glassboro Road
 Clayton, NJ 08312
 215-339-6379 (W)

Tracktime, Inc.
 4464 Little John's Place
 Youngstown, OH 44511
 216-793-1159

Ron Fox Enterprises
 150 Marion Drive
 West Orange, NJ 07052
 201-783-7800 (Daytime)
 201-736-9592 (Evening)

OTT - Ottawa
 Chris Kirby

PRECISION MOTOR WORKS

- Expert Mechanics
- Servicing All Porsches
- Large Inventory Of Parts

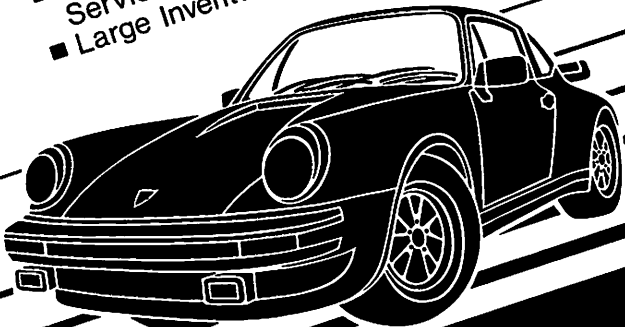

CALL 303 KOERBEL
527-6025
8 N. ROBERTS RD.
ROSEMONT PA. 19010



AUTOCROSS EVENTS

Sponsor	Date	Location
SCCA - NAT'L	9/14-18	ask Vern Lyle
SCCA	9/27	Plymouth Meeting Mall
SCCA	10/4	TBA
BMC	10/11	GCCC
SUSQ	10/18	Hershey
SUSQ	10/25	Hershey
BMTN	10/25	Kutztown
BMTN	11/1	Kutztown
SUSQ	11/8	Hershey
SUSQ	11/22	Hershey
SUSQ	12/6	Hershey

RTR = Riesentoter PCA
SCCA = Philadelphia Region, SCCA
SUSQ = Susquehanna Region, SCCA
BMC = Brandywine Motorsport Club
BMTN = Blue Mountain, SCCA

1987 SOLO I SCHEDULE

	<u>NEDIV SCCA</u>
Oct 3 - 4	Fall Weatherly Hillclimb (NEPA Region)
	<u>SEDIV SCCA</u>
Apr 24 - 26	Chimney Rock Hillclimb (Central Carolinas Region)

* 1987 SCCA GCR and Solo I rules apply

* Drivers must be members of SCCA and have a Solo I or other recognized license

* For further information contact Jess Holshouser at 766-8201

TRACK EVENTS, ETC By Bob Lamb

I have mixed feelings about this year's driver's ed program. We had a new event at Pocono early in the season that appeared to be well received. We had a mid-summer event at Summit Point that was over subscribed. The Planned highlight of the year was to be at the Glen in early October. Unfortunately, the Glen event was cancelled by the track due to unforeseen construction and repaving. However, we have a weekend date for next year.

Last December I came up with the wild idea of a drag race. I tested the idea with a number of people and there appeared to be interest. Arrangements were made with a first class facility at Maple Grove near Reading, Pennsylvania. Due to the cost of renting the track, we decided to run the event like a driver's ed event with advance registration. We needed 60 entries to break even and we had less than 20 registrants. We had no alternative but to cancel the event. I was a little surprised and disappointed with the slim interest.

When the Glen event was cancelled some members wondered why we did not attempt to arrange another event this year. Most tracks have their schedules set 9 months to 1 1/2 years ahead. Other clubs have competing events scheduled. It takes 3 to 4 months advance work to advertise, promote and conduct registration, etc. prior to an event. There simply were few to no track dates available and enough time to promote another event this year.

If you want to participate in more events than our club conducts, it is very easy to enter other regions' events. You simply have to contract their Track Chairman several months in advance, get an application form and send it in on the first day of registration. In my own case, I just calculated that 70% of the events I have attended were run by other clubs. It is really very easy. You will meet many new people and experience new and different tracks.

THE STUMBLE START

By Tony Checkowski

Has your 911 been getting hard to start? Has this taken place over a long period of time? Does it stumble when it starts? Do you remember when it started immediately?

After spending too much time and money at one of our local Porsche shops, a friend of mine and I decided to see if we could resolve the puzzling problem.

Everything pointed to the warm-up regulator as the cause for the stumbling start, since it provided a controlled pressure when the engine was cold. A check indicated that the warm-up regulator pressure was fine, if not perfect. It was tempting to change the regulator anyhow and if it didn't cost so much, it would have been done.

Looking at the electrical schematic indicated that as the ignition switch is turned to the start position, the cold start valve is energized provided the thermo-switch is at a ground potential. The cold start valve injects fuel into the intake ducts just as long as the key is turned to start and the thermo-switch is at ground. What opens the ground at the thermo-switch is the heating of the bi-metal thermo contact metal. If the engine is warm or cranked too long (about 8 to 10 seconds), the switch is also lifted from ground and the cold start valve shuts off. This prevents flooding of the engine with too much gasoline.

A check of my thermo-switch showed that there was high resistance to ground. A resistance of 50 to 60 ohms indicated that the cold start, which electrically activated, probably never or opened or opened so little that very little fuel was injected, hence the stumble start. Such a problem creeps up slowly on you. It may take a long time before the resistance creeps up and reduces the fuel quantity injected by the cold start valve.

The thermo-switch is located on the left side of my chain tension cover. Take an ohm meter and remove the two leads on the thermo-switch (red, yellow). Check the resistance of the contacts to engine ground. You should read zero on one and about 25 ohms on the other (red to ground @ 0 ohms, yellow to ground @ 25 ohms).

I bought a new thermo-switch, P/N 91161711700 for \$56.00, and got my new regulator start back on the 2.7 liter engine.

What many of us with no solution to the stumbling problem do, is use the enrichment mixture handles, if we have them. This avoids the problem for a while. Be sure the engine is cold before you check the thermo-switch.

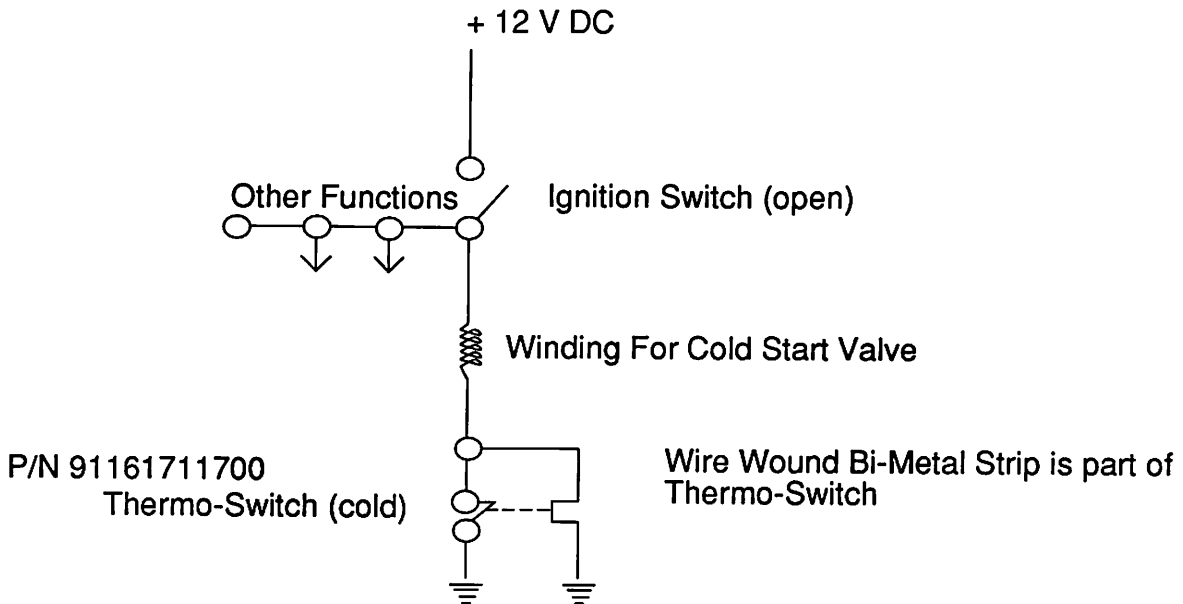

Reisentoter's Octoberfest, Tuesday, October 27th \$15.00 per person

NAME	COST
TOTAL AMOUNT INCLUDED \$	

RHEINLAND INN, GREEN LANE 679-9339
 6:30 INN OPENS
 7:00 DINNER IS SERVED
 8:15 VOTING STOPS, START MEETING
 8:45 RUSSO'S AUCTION BEGINS

FRUIT CUP
SALAD
SAUERBRATEN, SPATZLE, RED CABBAGE
BLACK FOREST CAKE
COFFEE, TEA, CASH BAR

DIRECTIONS: (A) Rt 363 to Sumneytown Pike, go West. It will become Rt 63 just south of the Lansdale exit of the Turnpike, or, (B) PA Turnpike NE extension to Lansdale exit (1st exit Northbound), go **RIGHT** onto Geryville Pike. The hotel sits in the crotch of the 'Y' formed by Sumneytown Road/Rt 63 and Geryville Pike. Follow this for 2.5 miles to Rheinland Inn on right. Parking is just past the Inn, which is a large stone building. If you go too far, you will come to a 'T' intersection.

Make checks out to: Riesentoter Region, PCA and mail them to:

BILL O'CONNELL
2801 STONEHAM DRIVE
WEST CHESTER, PA 19380

QUESTIONS???
CALL 640-1675



mgsTrailers



Hitch up to a Winner!

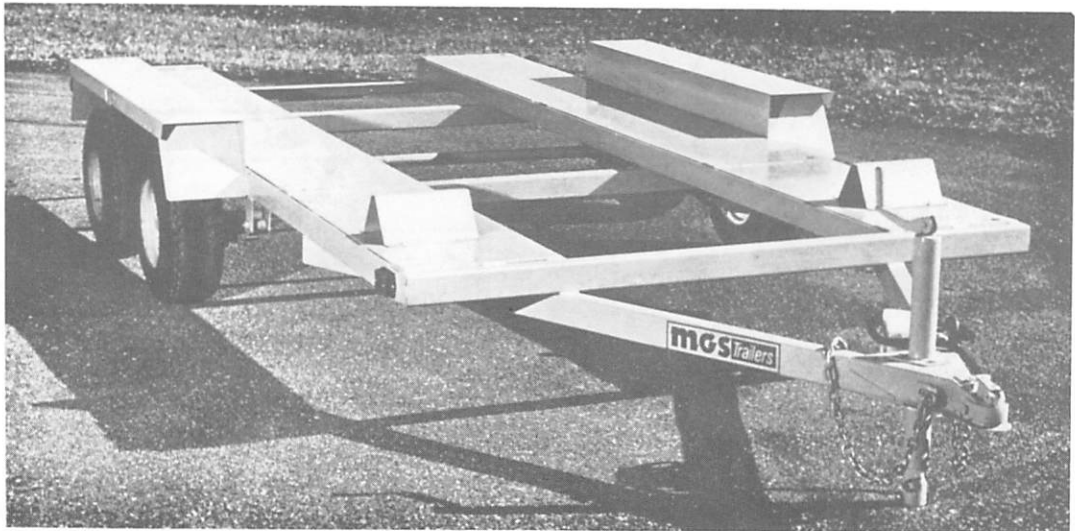

MGS Car Trailer Model C122

STANDARD EQUIPMENT AND SPECIFICATIONS

- Capacity: 4000 lbs. GVWR
- Empty Weight: 1150 lbs.
- Overall Length: 15' 8"
- Tires: 8.00 x 10 C
- Overall Width: 7' 5"
- Deck Height: 17"
- Deck Size: 70" x 12"
- Slide In Rear Loading Ramps

Full Service
State Inspection
&
Tire Racks, Too!



MGS INCORPORATED
RD 3, Denver, PA 17517

8-5 Week Days
8-12 Sat

Thomas Herr
Phone 215-267-7528

All That Jazz

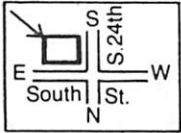

**THE SOUND PLACE
FOR YOUR CAR...
AND MORE**

**CAR TELEPHONES, AUDIOS, ALARMS
AND OTHER ACCESSORIES AND GIFTS**

617 South
24th Street,
Philadelphia
PA 19146
Tel.
545-5293
Free
Parking

**"We'll make your car
look like it did
the day you bought it."**



We hand wash and detail cars and don't miss a thing. We even clean the door jams. I use my wife's Q-Tips* to scour the air conditioning vents. When we're finished there shouldn't be a mark on the car. Most of my customers are in awe. The rest are ecstatic.

**Arthur's Professional
Automobile Care, Inc.**

117 N. 23rd Street (Between Race & Arch)
215-557-9525

Auto Salon, Inc.

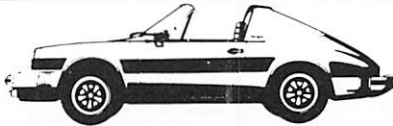

DETAILED CLEANING OF FINE AUTOMOBILES
Polishing — Waxing — Interiors

**Your car is an investment, why not treat it like one?
Auto Salon, Inc. will add to the life and value of your
automobile, while keeping that showroom shine.**

Valet and Gift Certificates Available **436-9331**

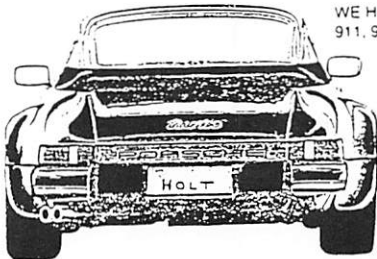

WE HAVE SOLD AND SERVICED HUNDREDS OF
911, 930 AND 928 PORSCHEs

WE OFFER:

- GENERAL SERVICE
- ENGINE AND TRANSMISSION
REBUILDING AND SUSPENSION
MODIFICATIONS
- 930 TURBO BOOST INSTALLATIONS
- TURBO AND INTERCOOLER
ENLARGEMENT
- ANY MODIFICATIONS TO YOUR
SPECIFICATION
- SLOPE NOSE BODY CONVERSION



INTERNATIONAL MOTORS

5300 ROUTE 70, PENNSAUKEN, NJ 08110
3 MIN. FROM BEN FRANKLIN BRIDGE

CALL TIM HOLT FOR INFORMATION
(609) 663-9222

CAR PHONES



Riesentoter members now receive preferred treatment when buying or leasing a car phone. We are experienced in PROPER phone installation for PORSCHEs, Mercedes Benz, BMW, and other fine cars. We will give your car the attention it deserves, no matter what make.

We install all major brands and are very competitive in our pricing. Whether you want to lease or buy, call MIGUEL at 677-9380 and mention this ad for the RTR exclusive.

CLASSIFIED

- **1976 930 #9306800111** Irish Green with Tan Leather Sport Seats, 18,500 mi, 935 Boost Gauge, UNGO Box, CB, 930 S Spoiler with Driver Lights, Goodyear Gatorbacks, Front Oil Cooler, 27/23mm Torsion Bars, ADJ Spring Plates & Rear Sway Bar, Solid Bushings with Grease Fittings, Brakes updated to late model 930 Dual Piston Calipers, SS Brake Lines, 23mm Master Cylinder, SS Headers, Euro Lights, Exceptional Condition, \$34,000, Bob Holland, 305 Staghorn Way, West Chester, PA 19380, 215-436-6577.
- **1979 924** New Silver Paint, New Dash. 92,000 miles. Garage kept, excellent condition. \$7,400.00 negotiable. Call Pat Minehan 279-4155.
- **'85 Carrera Cabriolet** WPOEB0917FS170218 Moss Green with full leather champagne sport seats, sport shocks, 16" alloy wheels, stereo-tape, cruise control, power locks, alarm, tonneau. Balance of 5 year warranty is transferable to new owner. \$39,500 or best offer. Days (215) 592-8786, evenings and weekends (215) 247-3466.
- **'85 911 Carrera** Prussian Blue Metallic, Color to sample Grey Beige interior. Full leather, cruise control, alarm, Blaupunkt Monterey stereo/tape, power sport seats, power locks, sunroof, climate control. Limited slip, spoilers, 16" wheels, sport suspension. Excellent Condition. 15,000 miles \$37,000. Call (215) 789-5226.
- **'83 911 Cabriolet**, one of a kind. Chiffon color. Matching alloy wheels. Dark green leather with mustard piping. Matching mats, limited slip, fog lights, alarm system, cassette holder, cut off switch. European light package. Add ons: Alex phone, Alpine radio with separate equalizer, built-in radar. 14,000 miles. \$35,000. (215) 343-3657 after 6PM.
- **'84 911 Turbo Look Carrera**. Platinum with Gray Beige. Immaculate. \$39,000. Richard van Zijl 854-6483 (days) 296-8862 (nights).
- **'82 911 SC Coupe** Wine Metallic, Tan Leather. Electric roof, windows, mirrors. Cruise, stereo, 16" wheels (P7's fair), front spoiler. Excellent running condition. 73,000 miles. \$18,000. Jack Klinges. (215) 536-9420
- **'77 924** White, Sunroof, 56K. \$5,800. Pirellis. Galbraith serviced. Pete Adams (W) 923-6614 (H) 666-5217.
- **'86 911 Carrera** Black w/Black Leather, Blaupunkt Monterey, 14,000 Miles, Chin Spoiler, Euro Lights. Call Ed 696-2164.
- **'73 914 2.0** liter. 49,000 miles. Fuchs alloys, appearance group, stainless heat exchangers, no rust, perfect black interior. \$5,900. Eric Osmunson (215) 791-2492 (H).
- **'74 914 2.0** 53,700 original miles, 7,150 miles on 135+ HP engine rebuild. 2nd owner of garage kept, club car, 911S alloy brakes + suspension, too many improvements to list. Please call for complete details \$2,000 invested asking \$11,000. Call Rich Benn (215) 825-5265 leave message.
- **'77 911 S Targa** Silver with Red interior, no rust, new Porsche paint, original mags, AM/FM, Cassette Stereo Recorder, Fog Lights, clean and good condition. Best Offer - Don Newby (215) 763-6006 (W).
- **'65 911** good condition White w/Burgundy. Restored 10,000 miles ago no rust. 80,900 miles. 10,000 miles on motor. \$7,500. Ben Auger 565-4084 (H) 972-0813 (W).
- Current hobby is forcing me to become fiscally responsible (finally?). The following vehicles must go away before this fall. All are in very good to excellent condition except the Mercedes, which needs some work because it has been sitting idle so long.
- 1) **1978 Ferrari 308 GTS**. Silver with black Boxer trim and red leather. All major service records. 15,000 miles. \$32,000.
 - 2) **1976 Porsche 930**. Absolutely a great classic. You won't believe the condition. Silver with red leather, sunroof, a radio I can't figure out. Service records. 12,500 original miles. \$32,000.
 - 3) **1984 BMW 533i**. Burgundy with pearl Beige interior. Records. 40,000 miles. \$17,500.
 - 4) **1982 VW Pick up Truck**. Dark red with tan interior. Pirelli Plus 1 wheel package with P-6 tires. Kamei front spoiler. Wever throttle Body, catalyst by-pass, and headers. Factory A/C, power steering, Momo leather steering wheel, etc., etc. 19,000 miles. Make offer.
 - 5) **1973 Mercedes 450 SE**. Maple with beige interior. Body and engine in good condition, but needs detailing. 80,000 miles. Make offer. Contact Craig Rosenfeld for more information. (215) 775-0997 Anytime.
- **'37 Carrera** Slopenose wide body conversion by Johnston. Black w/black leather. 1,100 miles, \$3,200 Blaupunkt custom sound system, remote alarm call Ed 696-2164.
- **'86 911 Turbo** Iris Blue w/black leather, 12,000 miles 9" and 11" Gotti modulars. Call Ed 696-2164.

- 2 - 8X15 Alloys Platinum centers good condition \$600

- 1 set Dust covers (brake) for 944 Never used \$20.
Mike Murphy 696-1114 (W).

- Porsche 911 Carrera Parts: 1 Cogan Bra - hardly used, front and rear bumpers - brand new, fog lights, complete brake system with brand new grooved rotors/DS11 brake pads, 4 Bilstein gas shocks, rear "banana" alloy trailing arms, 1 complete exhaust system including heater boxes, catalytic converter and stainless steel muffler. 1 complete motronic injection system. 1 complete cruise control system. 1 complete backseat assemblies - dark blue leather. 2 - 7X15 BBS single piece alloy wheels - Brand New. 2 - 8X15 BBS single piece wheels - used/good condition. 2 - 9X15 BBS single piece wheels - used good condition. Call Dave Smith, (215) 944-8913 - morning and evening.

7X15 - 8X15 BBS wheels, 225 50 - 245 50 Comps. Both new, mounted and balanced \$800.

IROC RSR Front Bumper Spoiler for 911SC brand new \$175.

Early 911S Bumper Spoiler, brand new, fitted and painted \$150.

4 911SC Headlights and trim rings \$50 each.

Complete interior for 944, grey, beige, leather sport seats with harness slot. \$1,000.

Al Anderson 275-6805 evenings.

- Wheels: 6x15 Fuchs Alloys From 1975 911s; Good condition; \$400; Russ Mullen; 215-493-9651.

- 911 Wheels and Tires from '86 Carrera, less than 1,000 miles, 2-6X15 and 2-7X15 telephone dials w/caps and Dunlop D4's 185/70VR15 and 215/60VR15. Asking \$700. Jeff Meyer 156 West Main St. Kutztown, PA 19530 (215) 683-5920.

- 944 car cover with bag. Used twice.

- 4 16" Goodyear VR Gatorback Tires. Your choice of size. Brand new, never mounted.

- 1 pair med Simpson Nomex driving gloves. Reasonable offers on all of the above. Bill O'Connell. 640-1675.

- Colgan 3 piece bra for 944 - New, in the box. Will include 2 mirror bras at \$80 you know this is a bargain! Jerry Weger 649-6618.

-4 Goodyear Eagle VR "S" Compound, 205-50-15's, very rare soft compound, full treads, 7/32's tread, great for autocross, track, or street. \$390.00 Don Meluzio, 717-846-2222.

-Goodyear Eagles VR "S" 205-50-15's, used tires, 2/32's tread, good autocross tires. \$10.00 each. Don Meluzio, 717-846-2222.

JOHNSTON

ENTERPRISES

*Cosmetic reconstruction of
Porsche and other fine
German automobiles*

- COLLISION REPAIR SPECIALISTS
- HEATED DOWNDRAFT SPRAY BOOTH
- FACTORY APPROVED CELETTE BENCH UNIBODY REPAIR
- CUSTOM BODY CONVERSIONS
- RESTORATIONS

325 WESTTOWN RD.
WEST CHESTER, PA. 19382
215-696-2164

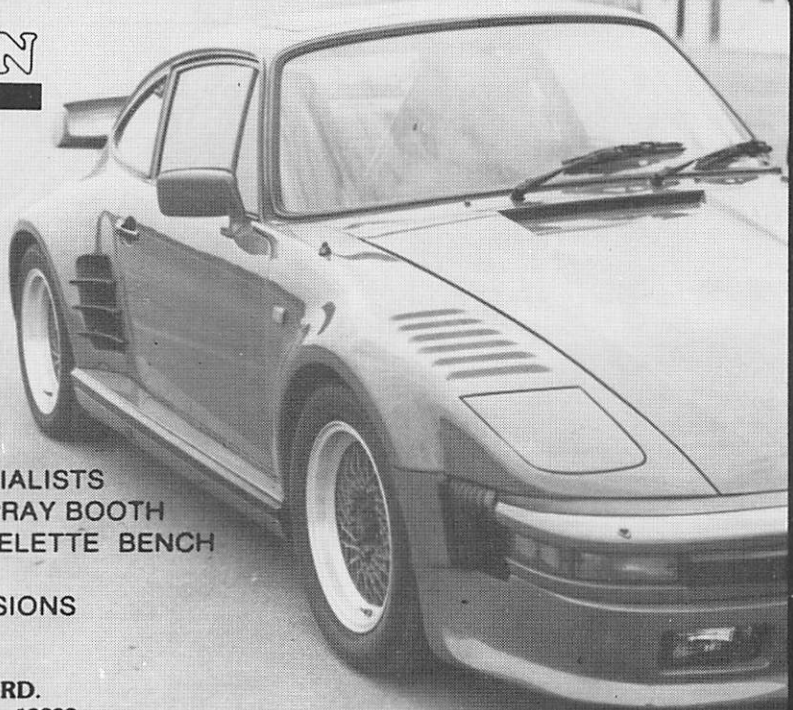

NTW

Performance Specialists

- Tires and Wheels
- Mounting and Alignment
- Computerized Alignment
- Brakes, Shocks, Full Automotive Service
- Special Discount For Car Club Members

YOKOHAMA BRIDGESTONE
PIRELLI GOODYEAR
MICHELIN
BF Goodrich

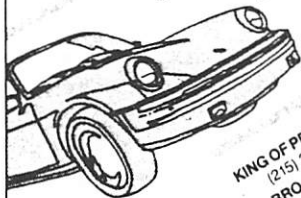

KING OF PRUSSIA, PA (215) 265-0900
 WILLOW GROVE, PA (215) 657-6600
 BROOMALL, PA (215) 328-3100
 WILMINGTON, DE (302) 478-8013

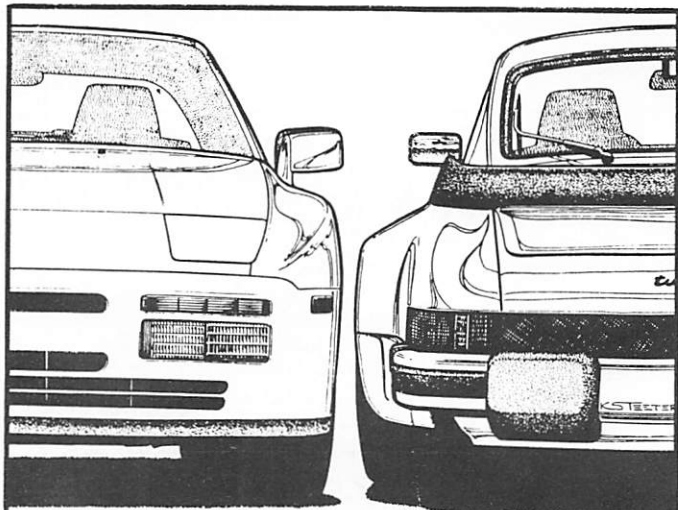

We'll take care of you coming and going.

Come to us for precision service on any model Porsche.
 Or go away in one of our impeccable, previously-owned Porsches.



Autofest

German Auto Sales/Service/Parts/Restoration
 Norristown, Pa
 215/277-4160



PERFORMANCE PRO SHOP

M.A. DOOLING & SONS
 7320 ELGIN AVE.
 PHILADELPHIA, PA 19111

JOSEPH M. DOOLING
 (215) 725-6550

LD

DETAILING LIMITED



COMPLETE CAR CARE

COMPLETE
 AT HOME SERVICE

RADIO
 & accessories
 INSTALLED

CONCOURS PREP
 Hand Wash/Wax
 Steam Cleaning
 Simoniz
 Compounding
 Engines Detailed

P.C.A. member

CALL:
 JOHN D. 364-2192
 ROBERT N. 357-4930

Dick HERRIGAN

PORSCHE

BMW

AUDI

VOLKSWAGEN

SUBARU

1015 Lancaster Ave.
 Reading, PA 19607

215-777-1500

P-215 WHEEL CLEANER-REGULAR FORMULA-COMPLETE KIT \$10.95

P215 WINDSHIELD WASH BOOSTER, "ENDS STREAKING FOREVER"?! \$4.95

P-215 PRODUCTS ARE RECOMMENDED BY PORSCHE TECH BULLETIN #8504 3-1-85

TECHRON FUEL INJECTION CLEANER-TANK ADDITIVE-LARGE BOTTLE \$7.95

FERODO BRAKE PADS-WE STOCK BOTH "M" AND "DS-11" COMPOUNDS-AT 10% OFF MOST PUBLISHED PRICES

SUNGARD WINDSHIELD SCREEN-PROTECTS AGAINST SUN DAMAGE TO DASHBOARDS

911-944-924 \$35.95

WHISTLER SPECTRUM 2-HIGH PERFORMANCE RADAR DETECTOR-WINNER IN 7 OUT OF 10 "CAR AND DRIVER" RADAR TESTS \$199.95

HELLA 7" HALOGEN HEADLIGHTS \$75.00 PAIR WITH BULBS

WOLF CAR COVERS-PROTECT AGAINST WINTER MONTHS AHEAD-ALL MODELS FROM \$89.95 AND UP!

BBS ROAD WHEELS FOR 911-GOLD CENTERS-7 X 16, 8 X 16-VISIBLE LUG NUTS LIST PRICE \$1536.00

SALE PRICED AT \$1150.00 ONE SET ONLY WE CAN ORDER ANY BBS WHEEL AT COMPETITIVE PRICES

WURTH-GERMAN MANUFACTURED CHEMICAL, SEALANTS, AEROSOL PRODUCTS:

-COCKPIT CLEANER-RECOMMENDED IN PANORAMA

-GLASS CLEANER

- "RUST" OFF-SUPERB!

-GASKET CEMENTS-SEVERAL TYPES

-ADHESIVES

-FORM-A-GASKETS

-UNDERCOATING (OEM) AEROSOL OR BULK

-THREAD SEALANTS

-GASKET REMOVER

BLAUPUNKT, PIONEER, CLARION, MITSUBISHI??? CALL FOR GREAT PRICES!!

LUBRO MOLY VALVE CLEAN-RECOMMENDED-ADD TO FUEL \$3.80

911 AERO QUIP BRAKE HOSES (4) \$57.50

WE CARRY A COMPREHENSIVE SUPPLY OF METRIC BOLTS, NUTS, LOCK NUTS, JAM NUTS, BRAKE FITTINGS, CIS INJECTION FITTINGS, AND POLYMAID FUEL HOSE (PLASTIC)- WE CAN FABRICATE **BRAKE AND FUEL LINE** TO MATCH YOUR DAMAGED PIECE IN MANY CASES FOR LESS DOWN TIME. RUBBER INJECTION, VACUUM, AND POWER BRAKE HOSE.

CASTROL DOT 4 BRAKE FLUID \$2.00 PINT

AIR BOX RELIEF VALVE KIT FOR CIS 911-WITH COLD WEATHER AND COLD STARTS AHEAD-PUT YOUR WORRIES BEHIND-INCLUDES VALVE, HOLE SAW, AND GLUE. \$65.50

INTERSTATE BATTERIES-IN STOCK- FROM \$65.50

CHECK OUR PRICES FOR **BRAKE DISCS, CALIPERS, AND CLUTCHES.**

WE CAN SUPPLY ALL **BOSCH PARTS, BOGE SHOCKS, BILSTEIN SHOCKS,** AND AN INCREDIBLE ARRAY OF GENUINE AND/OR AFTERMARKET PARTS.

FREE OIL FILTER WITH OIL CHANGE DURING SEPTEMBER, OCTOBER, AND NOVEMBER.

FREE TECH INSPECTION FOR AUTOCROSS OR TRACK EVENTS IN CONJUNCTION WITH OIL CHANGE OR BRAKE SYSTEM FLUSH - **MUST HAVE A BONA-FIDE TECH INSPECTION FORM.**

944 SPEC BOOK "82-83" \$9.95

BAD VIBRATIONS?-COMPUTER SPIN BALANCE YOUR WHEELS AND RETURN FROM MULTIPLE VISION TO A CLEAR VIEW - SEPTEMBER, OCTOBER, NOVEMBER ONLY AT \$7.00 A WHEEL - INCLUDES TAPE WEIGHTS OR CLIP ON TYPE - FREE BRAKE CHECK ON SAME AXLE AS BALANCED WHEEL.

WE HAVE ALL THE **BOSCH EQUIPMENT** TO SERVICE OR DIAGNOSE INJECTION SYSTEMS. ADDITIONALLY, OUR **SUN INTERROGATOR COMPUTER** CAN PRINT OUT A THOROUGH OPERATING SYSTEMS TEST AND RECOMMEND REPAIRS.

STOP IN FOR A FREE COPY OF THE LATEST "AUTOMOTION" CATALOG; LIMITED SUPPLY.

WE CAN SUPPLY ANY ITEM AND INSTALL IT- SAVE SHIPPING CHARGES AND ORDER THRU US.

DOUGHERTY AUTOMOTIVE SERVICES

614 WESTTOWN ROAD

WEST CHESTER, PENNSYLVANIA 19382

AMEX VISA (215) 692-6039 MASTERCHARGE

A.S.E. CERTIFIED MECHANICS

STATE AND EMISSION INSPECTION

